

# Fuel Gas Pressure Control Solutions for Fired Heaters and Boilers



Solutions for safer and more reliable operation  
of fired heater fuel gas systems.





Prevent process downtime by keeping your critical heaters online.

## Fuel Gas Systems

Fired heaters and boilers are essential components of most refineries, chemical plants and power generation facilities. Whether helping to power a steam turbine generator or the direct heating of hydrocarbons to make gasoline, the fundamentals of fuel gas pressure control are relatively standard across a wide range of fired heater applications.

### Power Generation

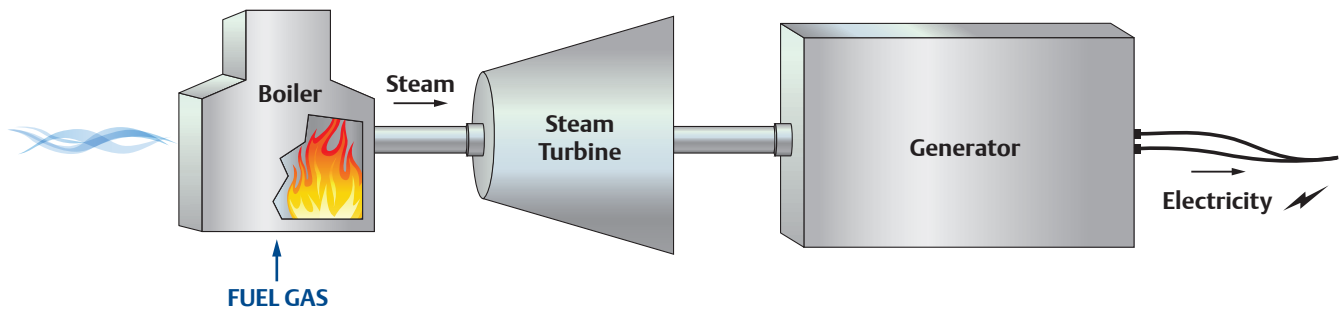

### Refining Process

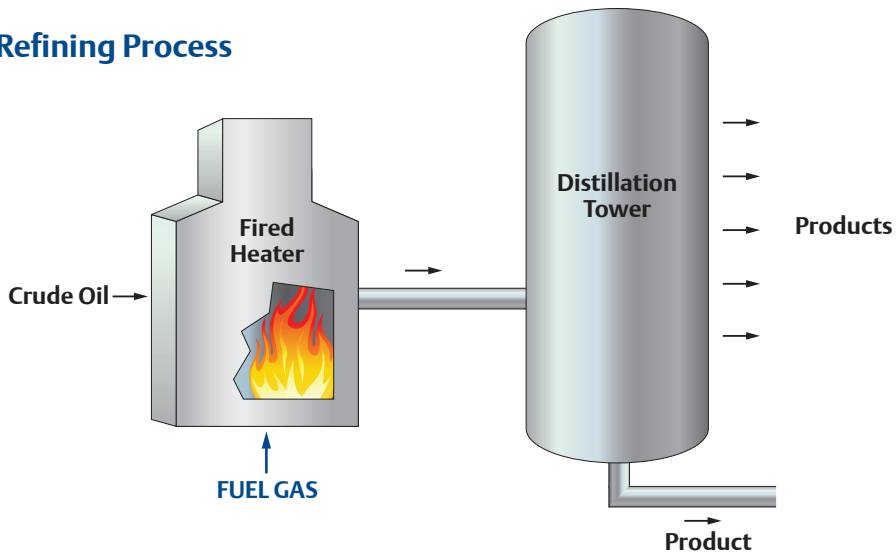



## Fuel Gas Pressure Control Challenges

- Inadequate speed of response of pressure control devices causing unplanned shutdowns
- Poor fuel gas quality or lack of routine maintenance leading to equipment failures
- Poor pressure control caused by improper equipment selection

### Fuel Gas Source

Although natural gas is the fuel most commonly used in a fired heater, many refineries and chemical plants mix process waste gases into their fuel systems. These process gases may contain heavy hydrocarbons that can cause build-up in the fuel gas lines. For sites that use waste gas, a higher rate of residue build-up is typical and must be accounted for in the pressure regulator selection and configuration.

### Fuel Gas Header Pressure Control

Because a fuel gas header can supply fuel to one or multiple fired heaters, reliability, speed of response, maintainability and noise limits are important design considerations when selecting a pressure control device.

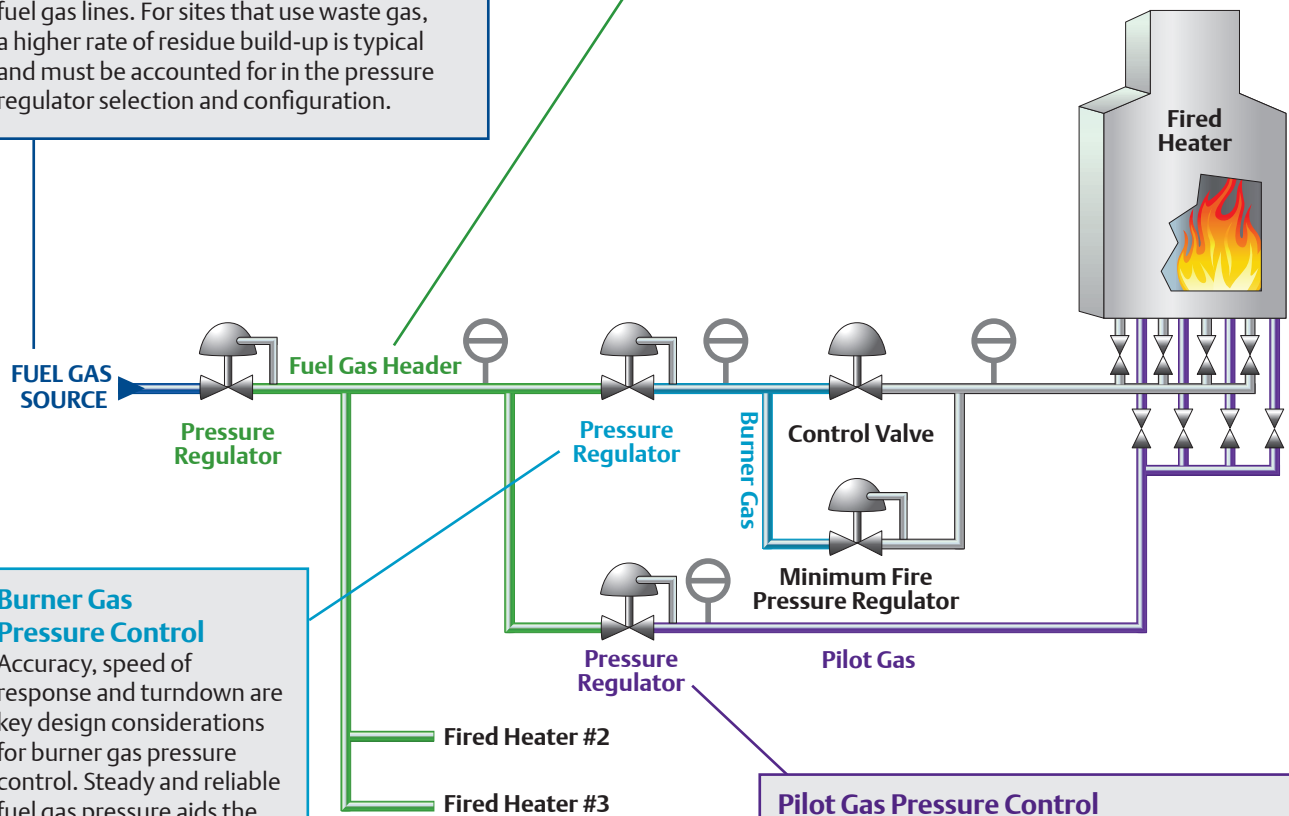

### Burner Gas Pressure Control

Accuracy, speed of response and turndown are key design considerations for burner gas pressure control. Steady and reliable fuel gas pressure aids the heater start-up process and ensures efficient fuel gas control to a fired heater.

### Pilot Gas Pressure Control

For pilot control, self-operated regulators are commonly selected because they are easier to maintain, less complex and have very high turndown capabilities when compared to other pressure control devices.

**Real World Solutions.** Emerson develops fuel gas pressure control solutions by first understanding the real-world requirements and challenges.





Minimizing the dangers associated with equipment start-up is a top priority.

## Fuel Gas Solutions

### Minimum Fire Pressure Control

Complicated burner management systems can hinder your ability to start a heater safely and quickly. An API 556-recommended minimum fire pressure regulator is essential when the fuel gas control valve lacks sufficient turndown to light the first burner.

This regulator not only helps minimize the complexity of the burner management system, but also reduces operator interaction during start-up. Simply set the regulator to the required setpoint during commissioning and it can remain untouched through multiple start-ups.

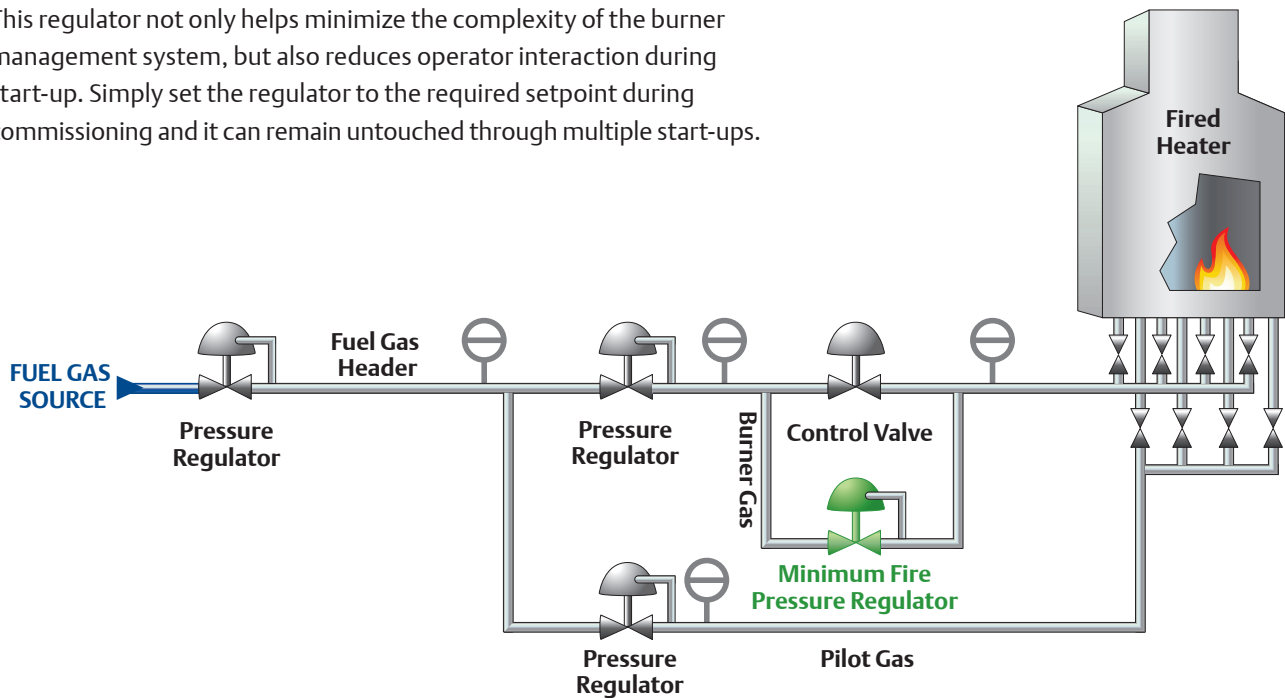

**Exceeding Standards.** Emerson regulators are designed to both meet and exceed applicable standards, helping keep your process compliant and safe.



## Monitor Setup

A monitor setup provides predictable control for certain pressure regulator failure modes without sacrificing pressure control performance. Commonly used in natural gas distribution by gas utilities, a monitor setup uses regulators in series to provide a layer of redundancy in the event the primary pressure regulator ceases to control downstream pressure. Monitor setups are recommended for use in fuel gas header and burner gas pressure control applications.

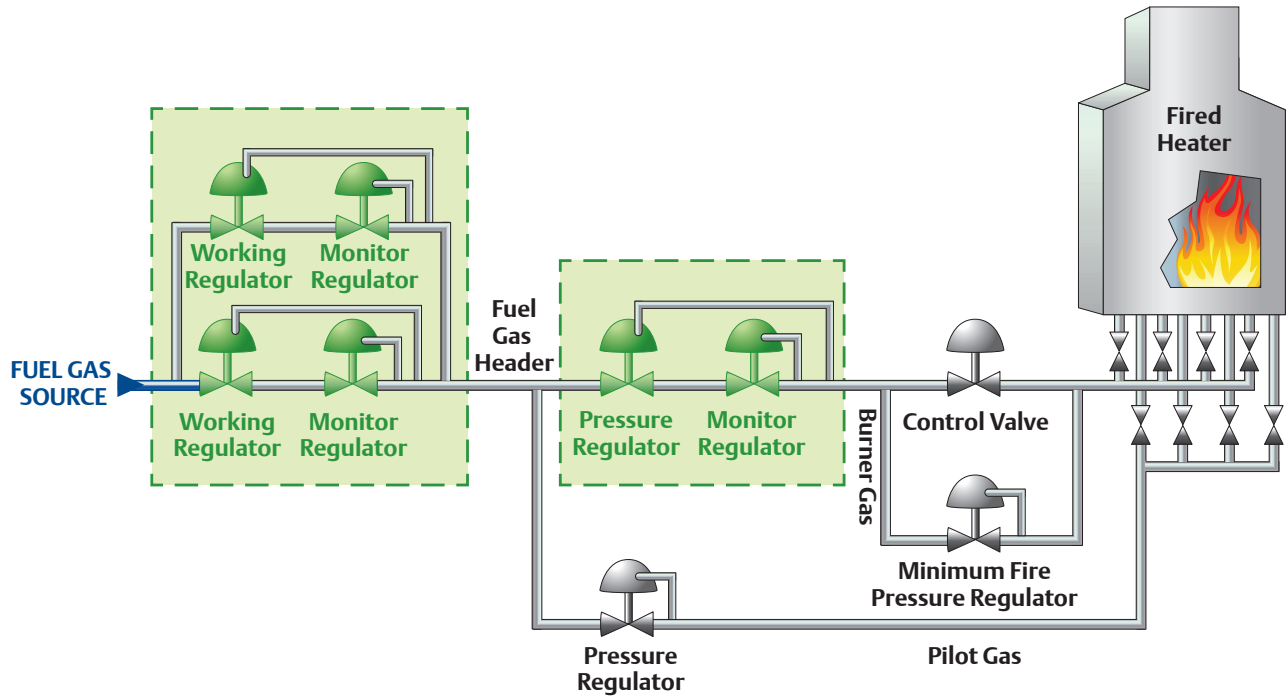

## Reliable Customized Systems.

For more than 80 years, Emerson has worked with customers to design monitor systems that provide a reliable pressure control solution. In addition to keeping your process online, monitor systems are easier to maintain and operate than other failure protection methods.





## Optional Features



### Wireless Position Indication

End users are often hesitant to use a pressure regulator, viewing it as a closed system that makes it difficult to determine if a regulator is working properly. Wireless position indicators can be used to detect and troubleshoot regulator problems on your existing control system before they impact your operation. They can be mounted on a variety of regulators to indicate real-time regulator performance, long-term degradation or a step change in process conditions.



### Slam Shut

The Emerson slam-shut valve is a mechanical device that will “slam shut” when it senses a high- or low-pressure event. With Class VI shutoff capability, the slam shut valve can be used to increase the safety of your fired heater shutdown system.

A slam shut valve can be installed independently or attached to an existing pressure regulator valve body to save space and reduce piping modifications. A solenoid valve can also be added to connect the slam shut to an existing safety system.

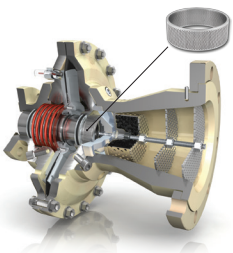

### Noise Reduction

High-pressure drops increase the possibility of high noise – a big concern for fuel gas heater pressure control when downstream demand can fluctuate. Noise attenuation options can reduce noise by up to 10 to 20 dB depending on the application.

## Innovative Technologies.

Emerson offers innovative solutions like remote monitoring options and emergency shutdown capability that can help minimize downtime and improve plant safety.





**Over 50% of unplanned shutdowns are related to human factors. Minimize unscheduled down time by increasing your knowledge. Rely on Emerson for expert assistance and training.**

## Unparalleled Support

### Expert help when you need it the most.

Emerson state-of-the art flow and materials labs provide an extensive worldwide network of engineers, application experts and sales professionals to help you size, select and troubleshoot your pressure regulators.

Emerson test and evaluation teams provide flow, material and environmental testing under real-world operating conditions before you place them in your application.

### Training to help you effectively maintain your systems.

No other regulator manufacturer in the world offers more products and local services dedicated to safe, effective applications than Emerson. We strive to be the leader in training pressure control personnel.

Emerson offers a wide array of onsite and offsite training for all levels of your organization. Together with our local business partners we work with you to develop training that fits the needs of your team, whether it is application training for engineers, operational training for operators or maintenance training for technicians. With our courses, your personnel can learn to:

- Perform maintenance on regulators
- Troubleshoot field problems
- Understand the influence of the service environment on regulator performance
- Properly size regulators

### Global Sales and Service.

Emerson sales and service offices are located strategically around the globe in North America, Latin America, Europe, Asia Pacific and the Middle East and Africa. With more than 2000 technical experts in nearly 200 offices, application support is just a call or click away.

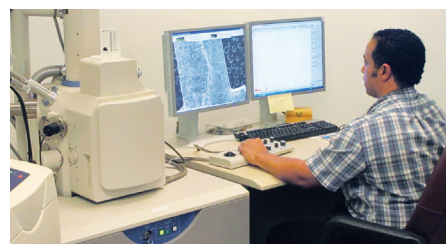

# Top-rated Products for Boilers, Burners and Fuel Gas Applications

## SELF-OPERATED REGULATORS

### Type 912N



**Body Size**  
NPS 1/4 or 1/4 x 3/8

**Max Inlet**  
250 psig / 17.2 bar

**Outlet Range**  
3 in. w.c. to 5 psig /  
7 mbar to 0.35 bar

**Max Flowrate**  
1030 SCFH / 27.6 Nm<sup>3</sup>/h

### Type Y600A



**Body Size**  
NPS 3/4 or 1 / DN 20 or 25

**Max Inlet**  
150 psig / 10.3 bar

**Outlet Range**  
4 in. w.c. to 7 psig /  
10 mbar to 0.48 bar

**Max Flowrate**  
6660 SCFH / 178 Nm<sup>3</sup>/h

### Type HSR



**Body Size**  
NPS 3/4, 3/4 x 1 or 1 NPT /  
DN 20, 20 x 25 or 25

**Max Inlet**  
125 psig / 8.6 bar

**Outlet Range**  
4 in. w.c. to 2.2 psig /  
10 mbar to 0.15 bar

**Max Flowrate**  
4800 SCFH / 129 Nm<sup>3</sup>/h

### CS200/CS400 Series



**Body Size**  
NPS 3/4, 3/4 x 1,  
3/4 x 1-1/4, 1, 1 x 1-1/4,  
1-1/4, 1-1/2, 2 / DN 20,  
20 x 25, 20 x 32, 25,  
25 x 32, 32, 40, 50

**Max Inlet**  
125 psig / 8.6 bar

**Outlet Range**  
3.5 in. w.c. to 5.5 psig /  
9 to 380 mbar

**Max Flowrate**  
12,000 SCFH / 322 Nm<sup>3</sup>/h

### CS800 Series



**Body Size**  
NPS 1-1/4, 1-1/2 or 2 /  
DN 32, 40 or 50

**Max Inlet**  
125 psig / 8.6 bar

**Outlet Range**  
3.5 in. w.c. to 10 psig  
/ 9 to 690 mbar

**Max Flowrate**  
36,270 SCFH / 974 Nm<sup>3</sup>/h

### Type 66



**Body Size**  
NPS 2, 3, 4 / DN 50,  
80, 100

**Max Inlet**  
10 psig / 0.69 bar

**Outlet Range**  
4 in. w.c. to 5 psig /  
10 mbar to 0.35 bar

**Max Flowrate**  
77,500 SCFH / 2077 Nm<sup>3</sup>/h

## Speed of Response

Speed of response is important in regulator selection for fuel gas services due to the fast load or demand changes typically required by fired heater applications. By design, fired heater start-ups and shutdowns can be abrupt. The regulator will need to sense this load change and respond quickly before the fuel gas pressure reaches the low or high safety trip point. Each of the regulator designs have different speed of response characteristics and the figure to the right provides some general guidance when it comes to pressure regulator selection.

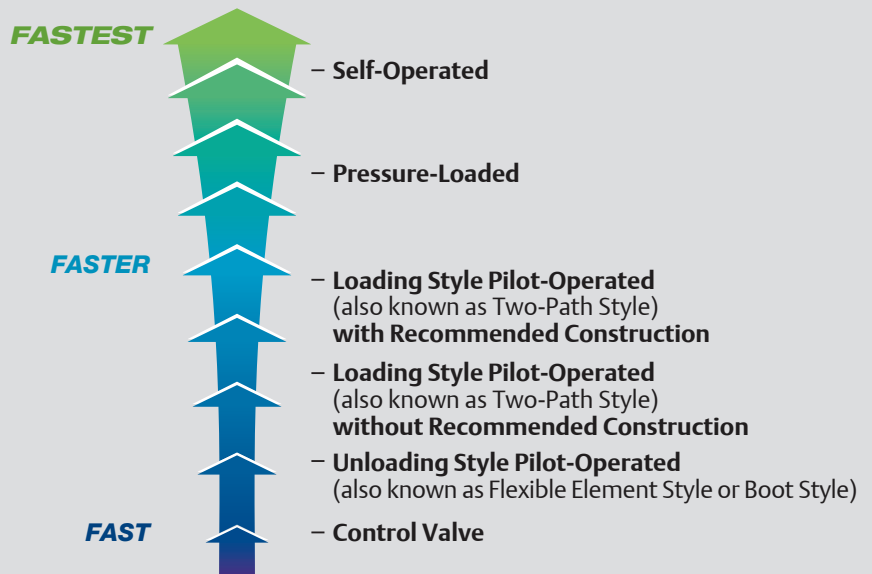



## 627 Series



**Body Size**  
NPS 3/4, 1, 2 / DN 20, 25, 50

**Max Inlet**  
2000 psig / 138 bar

**Outlet Range**  
5 to 500 psig /  
0.34 to 34.5 bar

**Max Flowrate**  
179,000 SCFH /  
4797 Nm<sup>3</sup>/h

## 133 Series



**Body Size**  
NPS 2 / DN 50

**Max Inlet**  
150 psig / 10.3 bar

**Outlet Range**  
2 in. w.c. to 60 psig /  
5 mbar to 4.1 bar

**Max Flowrate**  
372,000 SCFH /  
9960 Nm<sup>3</sup>/h

## MR95 Series



**Body Size**  
NPS 1/4, 1/2, 3/4, 1, 1-1/2,  
2 / DN 15, 20, 25, 40, 50

**Max Inlet**  
1000 psig / 68.9 bar

**Outlet Range**  
2 to 400 psig /  
0.14 to 27.6 bar

**Max Flowrate**  
510,000 SCFH /  
13,600 Nm<sup>3</sup>/h

## T205



**Body Size**  
NPS 3/4 or 1 / DN 20 or 25

**Max Inlet**  
200 psig / 13.8 bar

**Outlet Range**  
1 in. w.c. to 7 psig /  
2 mbar to 0.48 bar

**Max Flowrate**  
12,919 SCFH / 346 Nm<sup>3</sup>/h



## PRESSURE LOADED/PILOT-OPERATED REGULATORS

### 1098 Series



**Body Size**  
NPS 1, 2, 3, 4, 6, 8 x 6, 12 x  
6 / DN 25, 50, 80, 100, 150,  
200 x 150, 300 x 150

**Max Inlet**  
400 psig / 27.6 bar

**Outlet Range**  
4 in. w.c. to 300 psig /  
10 mbar to 20.7 bar

**Minimum Differential Requirement**  
1 to 28 psi / 0.07 to 1.9 bar  
depending on construction

#### Recommended Construction

Fast open or fast closing Type 61 pilot option/  
quick-open cage/lightest possible main spring,  
dual pilot construction

### 99 Series

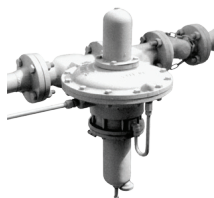

**Body Size**  
NPS 2 / DN 50

**Max Inlet**  
1000 psig / 69.0 bar

**Outlet Range**  
2 in. w.c. to 100 psig /  
5 mbar to 6.9 bar

**Minimum Differential Requirement**  
0.75 to 10 psi / 0.05 to  
0.7 bar depending on  
construction

#### Recommended Construction

Fast Open or Fast Closing  
pilot option

### CP200/CP400 Series



**Body Size**  
3/4, 3/4 x 1, 3/4 x 1-1/4,  
1, 1 x 1-1/4, 1-1/4, 1-1/2,  
2 / DN 20, 20 x 25, 20 x  
32, 25, 25 x 32, 32, 40, 50

**Max Inlet**  
125 psig / 8.6 bar

**Outlet Range**  
1 to 20 psig / 0.07 to 1.4 bar

**Max Flowrate**  
17,600 SCFH / 472 Nm<sup>3</sup>/h

FEATURES AVAILABLE:



Wireless



Slam Shut



Monitor



Noise Attenuation



Travel Indicator

# Top-rated Products for Boilers, Burners and Fuel Gas Applications

## PRESSURE LOADED/PILOT-OPERATED REGULATORS

### 299H Series



**Body Size**  
NPS 1-1/4, 1-1/2, 2 /  
DN 32, 40, 50

**Max Inlet**  
175 psig / 12.1 bar

**Outlet Range**  
3.5 in. w.c. to 60 psig /  
9 mbar to 4.1 bar

**Minimum Differential Requirement**  
1.5 psi / 0.10 bar

**Recommended Construction**  
Dual registration using  
3/4 in. piping

### EZL Series

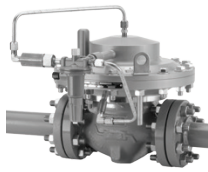

**Body Size**  
NPS 2, 3 and 4 /  
DN 50, 80 and 100

**Max Inlet**  
290 psig / 20.0 bar

**Outlet Range**  
7 in. w.c. to 300 psig /  
17 mbar to 20.7 bar

**Minimum Differential Requirement**  
2.9 to 0.39 psi / 0.20 to  
0.03 bar depending on  
construction

**Recommended Construction**  
Fast open or fast closing  
Type 61 pilot option

### EZH Series

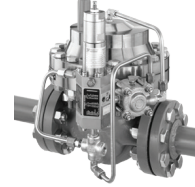

**Body Size**  
NPS 1, 2, 3, 4, 6, 8,  
and 12 x 6 /  
DN 25, 50, 80, 100, 150  
200 and 300 x 150

**Max Inlet**  
1500 psig / 103 bar

**Outlet Range**  
14.5 to 1160 psig / 1 to  
80 bar

**Minimum Differential Requirement**  
12.8 to 16.4 psi / 0.88 to  
1.13 bar depending on  
construction

**Recommended Construction**  
Type 32A or PRX / 131

### EZR Series



**Body Size**  
NPS 1, 2, 3, 4, 6 and 8 /  
DN 25, 50, 80, 100, 150  
and 200

**Max Inlet**  
1050 psig / 72.4 bar

**Outlet Range**  
6 in. w.c. to 1000 psig /  
15 mbar to 68.9 bar

**Minimum Differential Requirement**  
12 to 43 psi / 0.8 to 3 bar

**Design**  
Unloading Style

### FL Series



**Body Size**  
NPS 1, 2, 3, 4, 6, 8 and 10  
/ DN 25, 50, 80, 100, 150,  
200 and 250

**Max Inlet**  
1480 psig / 102 bar

**Outlet Range**  
14.5 to 1160 psig / 1 to  
80 bar

**Minimum Differential Requirement**  
7.3 to 14.5 psi / 0.5 to  
1.0 bar depending on  
construction

**Recommended Construction**  
Type 32A or PRX/131

### Type 310A

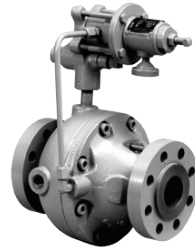

**Body Size**  
NPS 1, 2, 3, 4, 4 x 6 / DN 25,  
50, 80, 100, 100 x 150

**Max Inlet**  
1480 psig / 102 bar

**Outlet Range**  
10 to 750 psig / 0.69 to  
51.7 bar

**Minimum Differential Requirement**  
15 psi / 1.03 bar

**Recommended Construction**  
Turbine startup trim

# Installation Tips

## Internal Sensing Units

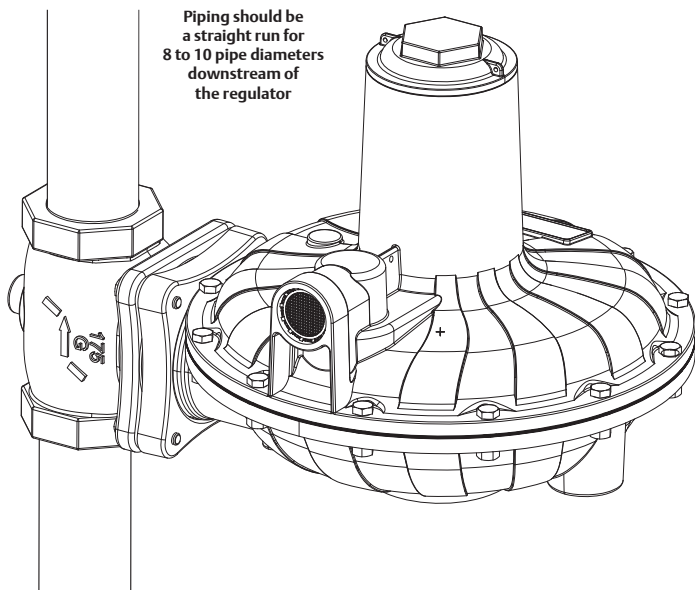

Proper installation of a fuel gas application minimizes shutdowns and restarts and helps ensure safe equipment operation, with less burner and flame fluctuations.

## Vent Lines

1. Best practices suggest that vent piping should be as large as the nominal size of the vent connection and increased one nominal pipe size for every 10 feet of linear pipe. (One elbow is equivalent to 3 feet of linear pipe.)
2. Verify the vent is oriented downward to protect it from the weather on applications without vent piping and ensure there is no moisture in the spring case.

## Improving Speed of Response for a Pilot-Operated Regulator

1. Speeding up closing
  - Increase size of pilot restrictor
  - Consider a pilot with a quick dump feature such as the 61 Series or Type 32A
2. Speeding up opening
  - Reduce size of pilot restriction
  - Increase differential pressure
  - Consider a faster pilot or larger pilot orifice size
  - Add an additional supply pilot which will quickly increase loading pressure

## External Sensing Units

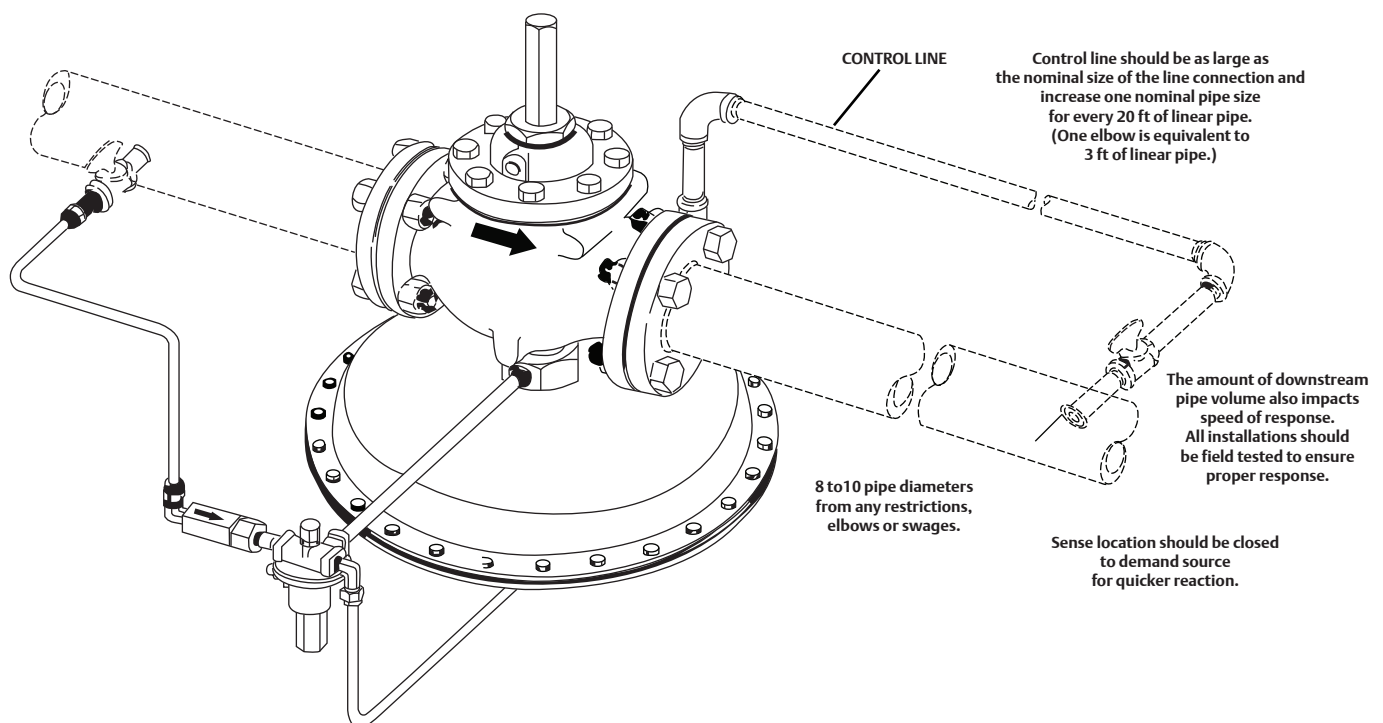

# Fuel Gas Pressure Control Solutions for Fired Heaters and Boilers



**FISHER™**

Emerson sales, service and technical support are as close as your telephone or on the web, anywhere in the world. Our distribution network offers a full complement of expert sales and support staff, and more than 2000 technical experts strategically located across nearly 200 offices worldwide.

## Emerson Automation Solutions

### Americas

T +1 800 558 5853  
T +1 972 548 3574

### Europe

T +39 051 419 0611

### Asia Pacific

T +65 6770 8337

### Middle East / Africa

T +971 4811 8100

 [webadmin.regulators@emerson.com](mailto:webadmin.regulators@emerson.com)

 [Emerson.com](http://Emerson.com)

 [Facebook.com/EmersonAutomationSolutions](https://www.facebook.com/EmersonAutomationSolutions)

 [LinkedIn.com/company/emerson-automation-solutions](https://www.linkedin.com/company/emerson-automation-solutions)

 [Twitter.com/emr\\_automation](https://twitter.com/emr_automation)

D352277X012 © 2015, 2017 Emerson Process Management Regulator Technologies, Inc. All rights reserved. 12/17.  
The Emerson logo is a trademark and service mark of Emerson Electric Co. All other marks are the property of their prospective owners.  
Fisher™ is a mark owned by Fisher Controls International LLC, a business of Emerson Automation Solutions.



**EMERSON. CONSIDER IT SOLVED.™**