

HEAVY
PUMPS

TOYO
PUMPS



HT TWINSTM

HS SERIES

SUBMERSIBLE SLURRY PUMPS UP TO 100 HP

RUN-DRY CAPABLE, VERSATILE & ECONOMICAL SUBMERSIBLE SLURRY PUMP SOLUTIONS

HEVVY PUMPS HISTORY



Where heritage meets imagination - the evolution of TOYO PUMPS.

In HEVVY PUMPS, we have created a product line that embodies both imagination and technological advancement. Over the course of our 40 year history as TOYO PUMPS, the company has progressively evolved. Our valued customers have helped to shape us, and from years of listening to their particular needs, dreams and continuous positive feedback - we created the HEVVY PUMPS product line to service these requirements. We don't believe in relying on past merits alone.

HEVVY pushes the limits of technology and design, to propel the future and challenge the industry to be more reliable, efficient and accountable to its customers and the environment. It is an exciting new future when "heritage" and "imagination" meet to benefit both worlds. With HEVVY and its new product lines, **we are ready to make a real impact globally.**

Make no mistake - the TOYO name has served us well. TOYO is a proven technology, despite being developed years ago. HEVVY is about embracing our proven technology and incorporating it into our new designs to both improve and create better products.

HEVVY PUMPS ADVANTAGE



HEVVY PUMPS are designed in-house by our engineers and crafted in North America using our own local workforce and know-how. HEVVY is our name and it signifies we are no lightweight.

HEVVY is a niche player in the solids handling market and knows the applications better than anyone else. This knowledge brings with it the following advantages:

- ▶ We can truly partner with our customers and consider ourselves an extension of our customer's operation.
- ▶ We are not trying to be everything to everybody and therefore do not have the unfocused range of product lines that most of our conglomerate competitors have. As a result we are able to move faster and adapt with technology.
- ▶ We realize that by gaining just five efficiency points, we can effectively save our customers thousands of dollars a year in electricity costs.
- ▶ We also realize that by not basing our business model on surviving off spare parts revenues, we can invest in designing pumps that actually last the test of time - thereby offering our customers a lower total cost of ownership.

We have named ourselves HEVVY - **perfectly summing up who we are & the industries we serve.**

HT TWINS™

ANTI-CLOG RUN-DRY SERIES

FOR CLASS 1 SLURRIES



- ▶ Anti-Clog Run-Dry design
- ▶ Balanced radial forces for longer bearing & seal life
- ▶ Increased wall thickness to withstand abuse
- ▶ Balanced shaft loading
- ▶ Large internal passages
- ▶ Top discharge
- ▶ Robust agitator
- ▶ High-Chrome wear components
- ▶ Double mechanical seal with SiC faces
- ▶ HI slurry class 1
- ▶ Built in thermal protection

HT TWINS™

MAIN FEATURES

FOR **CLASS 1** SLURRIES

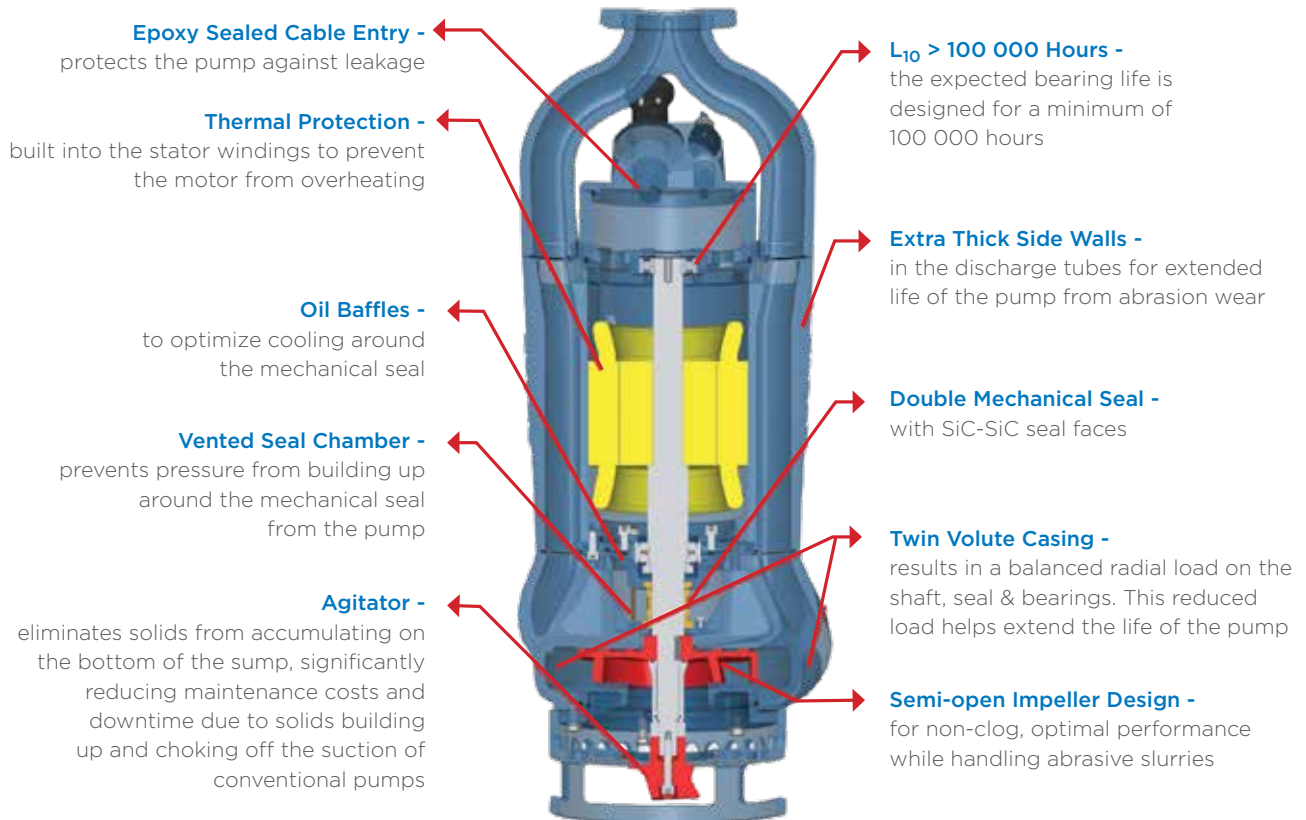

ADVANTAGE

BALANCED RADIAL FORCES

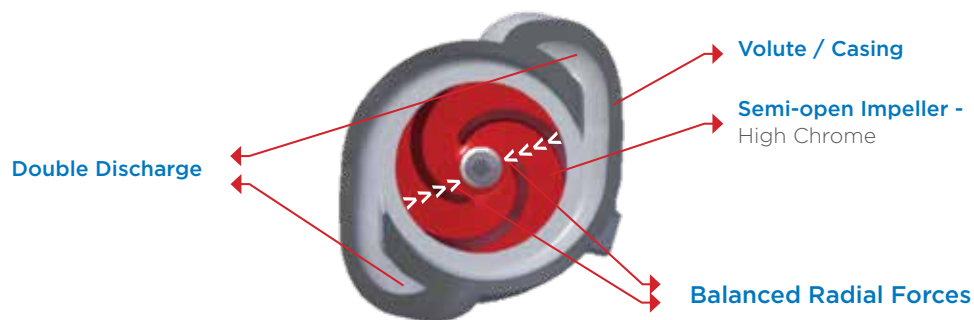

With the **Twin-Volute** design, the thrust force is balanced by **opposing 180 degree discharge outlets**. The result is less loading on the motor bearings and seal which will extend the life of the pump.



HT SUBMERSIBLE PUMPS



Robust Medium Duty Slurry Pumps

HT PUMPS are capable of pumping CLASS 1 slurries

HT FAMILY CURVE (60Hz)

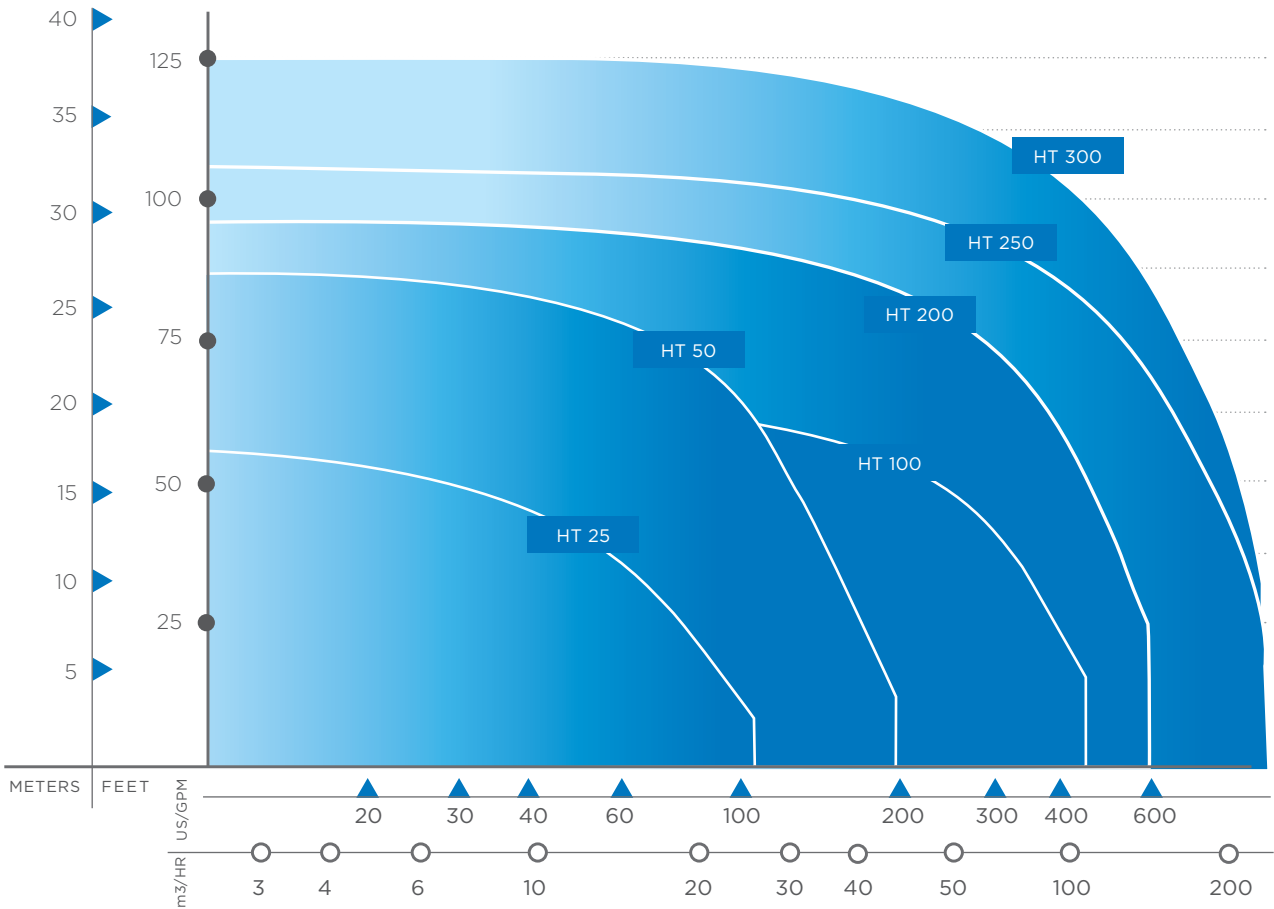

MODEL NUMBER	HT-25		HT-50		HT-100		HT-200	HT-250	HT-300
Discharge diameter - in (mm)	3 (75)		3 (75)		4 (100)		3 (75)	4 (100)	4 (100)
Flow at rated point USgpm (m ³ /h)	60 (13.6)	50 (11.4)	100 (22.7)	80 (18.2)	250 (56.8)	200 (45.4)	350 (80)	560 (127)	630 (143)
Head at rated point - ft (m)	40 (12)	25 (8)	66 (20)	46 (14)	48 (14.6)	30 (9.0)	68 (21)	72 (22)	86 (26)
Impeller diameter - inch (mm)	4.3 (110)		5.1 (130)		8.1 (205)		9.8 (248)	9.8 (250)	11 (280)
Max. solid size - inch (mm)	0.47 (12)		0.59 (15)		1.18 (30)		1.18 (30)	1.18 (30)	1.18 (30)
Weight w/ cable (std. length) - lb (kg)	125 (57)		158 (72)		339 (154)		624 (283)	1130 (513)	1145 (520)
Standard seal	Double mech. seal		Double mech. seal		Double mech. seal		Double mech. seal	Double mech. seal	Double mech. seal
Oil capacity - Mech seal - oz (ml)	9.3 (275)		11.8 (350)		22 (650)		30 (900)	68 (2000)	68 (2000)
Motor HP	3		5		7.5		15	25	30
Phase	3		3		3		3	3	3
Speed - RPM	3420	2850	3440	2865	1705	1425	1735	1750	1749
Frequency - Hz	60	50	60	50	60	50	60	60	60
Voltage - V	460/575	380	460/575	380	460/575	380	460/575	460/575	460/575
Rated current - Amps	4.3/3.5	5.1	6.7/5.3	8	10.2/8.3	13.6	18.9/15.1	32.1/25.7	35.8/28.6
Motor protector - Klixon	Yes		Yes		Yes		No	No	No
Motor protector - MTP	No		No		No		Yes	Yes	Yes
Moisture sensor + relay	N/A		N/A		N/A		Yes	Yes	Yes
Starting method	DOL		DOL		DOL		DOL	DOL	DOL
Motor service factor	1.15		1.15		1.15		1.15	1.15	1.15
Std. power cable	SOOW		SOOW		SOOW		SOOW	GGC	GGC
Std. sensor cable	SOOW		SOOW		SOOW		SOOW	SOOW	SOOW
Electric cable length - ft (m)	50 (15)		50 (15)		50 (15)		50 (15)	50 (15)	50 (15)
Insulation Class	F		F		F		F	F	F
Max pump temp Std °F (°C)	104 (40)		104 (40)		104 (40)		104 (40)	104 (40)	104 (40)
Shaft	410SS		410SS		410SS		410SS	410SS	410SS
Pump casing (Std)	Hevvy Hard Iron		Hevvy Hard Iron		Hevvy Hard Iron		Hevvy Hard Iron	Hevvy Hard Iron	Hevvy Hard Iron
Impeller	HCr		HCr		HCr		HCr	HCr	HCr
Suction cover	HCr		HCr		HCr		HCr	HCr	HCr
Agitator	HCr		HCr		HCr		HCr	HCr	HCr
Max Submergence - ft (m)	100 (30)		100 (30)		100 (30)		100 (30)	100 (30)	100 (30)

MINE READY HT - THE HT-MS SERIES OPTION

HT-MS Series pumps come standard with a shielded power cable equipped with a built-in diode for ground fault monitoring with available option to upgrade the pump casing to high chrome.

HS SUBMERSIBLE

EXTENDED RUN-DRY PUMPING UP TO 100 HP

FOR CLASS 1, CLASS 2, & SOME CLASS 3 SLURRIES

- ▶ Two Wet End designs available to suit your application needs:
 - S** - semi-open impeller
 - E** - vortex impeller with axial spiral casing
- ▶ Robust agitator
- ▶ Sizes up to 100HP
- ▶ Extended Run-Dry motor
- ▶ Anti-vortex oil veins
- ▶ Tandem double mechanical seals with TC faces
- ▶ High Chrome wear components
- ▶ Bearings are sealed & greased for life
- ▶ Vented seal chamber
- ▶ Class H insulation
- ▶ Built in thermal protection



IT'S ALL IN THE SEAL

A robust mechanical seal is an essential part of any successful slurry pumping formula which is why when we designed the **HS pump** we made sure we engineered the perfect seal to accompany it.

HS Series seals are individually protected and in tandem configuration. This means each set of springs are protected from the slurry and provides equal and real back up in the event a lower seal is compromised.



Next, we made some industry leading advancements in the seal chamber itself. We incorporated anti-vortex oil veins, which ensure the seal remains clean and lubricated without the internal eddies and vortexes created by oil lifters. Then, we boosted the pressure venting in the seal chamber to allow for greater submergence as well as less internal pressure on the seal itself.

All this means you get the best bang for your buck while having the peace of mind that we invested our time in all the right places.

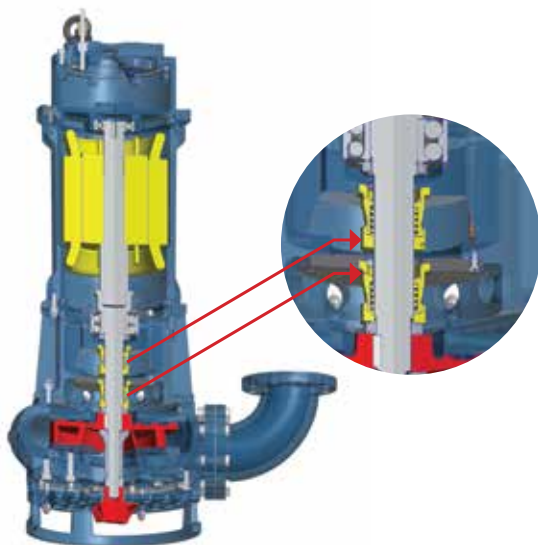

- ▶ Tandem double mechanical seals
- ▶ Independent seals with independent springs
- ▶ Rubber encapsulated springs for slurry protection
- ▶ TC-TC seal faces
- ▶ Operating in oil bath
- ▶ Anti-vortex oil veins which reduces the internal eddies and vortexes created by oil lifters
- ▶ Moisture sensor
- ▶ Pressure balanced seals for greater submergence: rated to 6 bar (200ft)

HS SUBMERSIBLE

EXTENDED RUN-DRY PUMPING UP TO 100 HP

MAIN FEATURES

FOR **CLASS 1**, **CLASS 2** & SOME **CLASS 3** SLURRIES

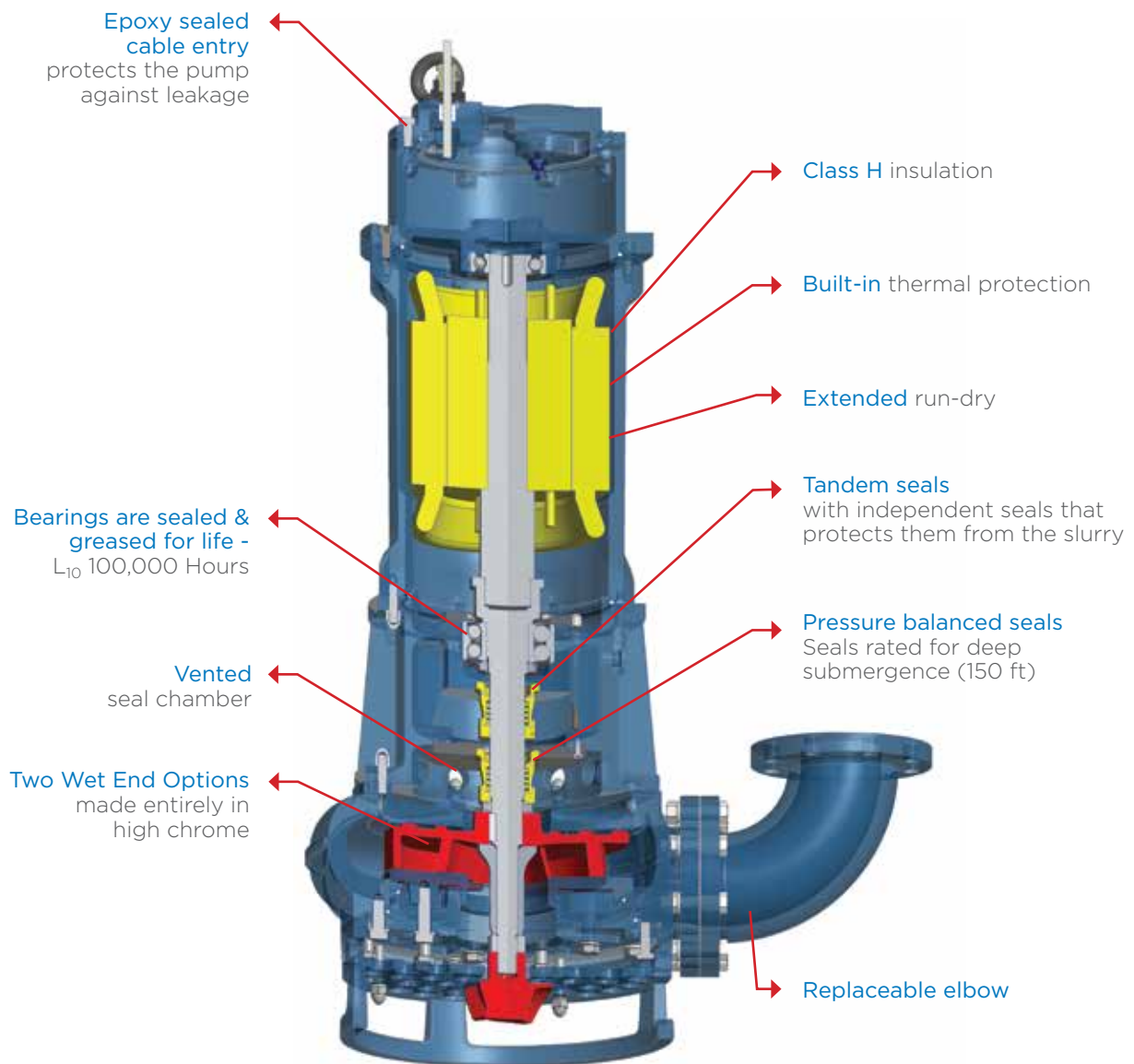

WET END DESIGNS

WET END SERIES	HS - E	HS - S
Impeller type	Vortex / recessed	Semi-open
Flow range - USgpm	4 000	3 000
Head range - ft	225	240
Impeller - number of vanes	8 - 12	3 - 4
Shaft	4140	4140
Pump casing STD	HCr	HCr
Pump casing OPT	CD4	CD4
Impeller	HCr	HCr
Wear plate - bearing side	HCr	N/A
Wear plate - suction side	N/A	HCr
Agitator	HCr	HCr
Chopper (optional)	Yes	No



The **E Wet End** has a fully recessed vortex impeller that permits an unobstructed passage of large solids. Fibrous material can also be handled without difficulty due to the natural flow of the fluid through the pump casing and the fact that the flow is virtually isolated from the impeller (only 15% of pumped liquid is in contact with the impeller). This pump is ideally suited for low shear applications.



The **S Wet End** is a fantastic semi-open, high efficiency, solids handling pump. This wet end is capable of handling Class 1, 2, & some Class 3 slurries. It boasts a special elliptical cut-water design which maximizes efficiencies and reduces wear.

E
WET END

**HS SUBMERSIBLE
PUMPS**



The **HS-E Wet End** has a fully recessed vortex impeller that permits an unobstructed passage.

This design allows solids with the same diameter of the discharge to pass through without the danger of clogging. It has some of the highest efficiencies available for a recessed impeller due to the unique axial spiral casing.

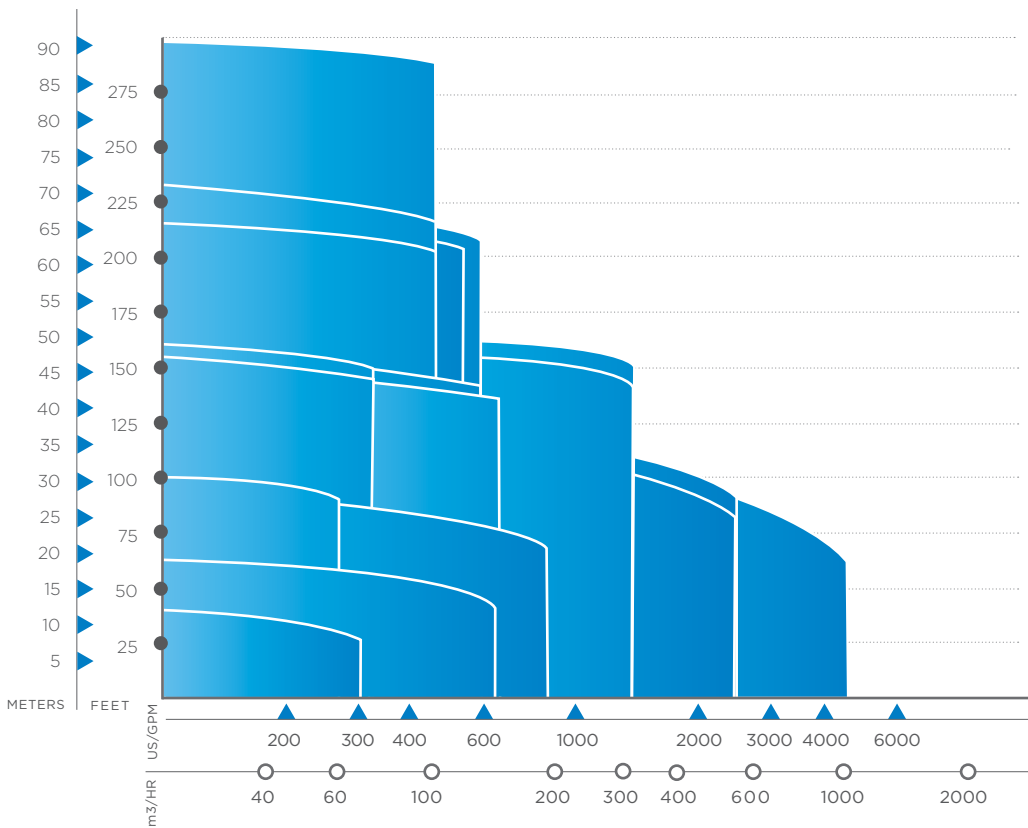

S
WET END



HS SUBMERSIBLE

PUMPS



The **HS-S Wet End** is a fantastic medium duty, high efficiency solids handling pump for Class 1, Class 2 and some Class 3 slurries.

This semi-open wet end boasts a special elliptical cut-water design to improve efficiency and reduce wear. It also has curved back vanes to help displace solids from behind the impeller and an adjustable front wear plate.

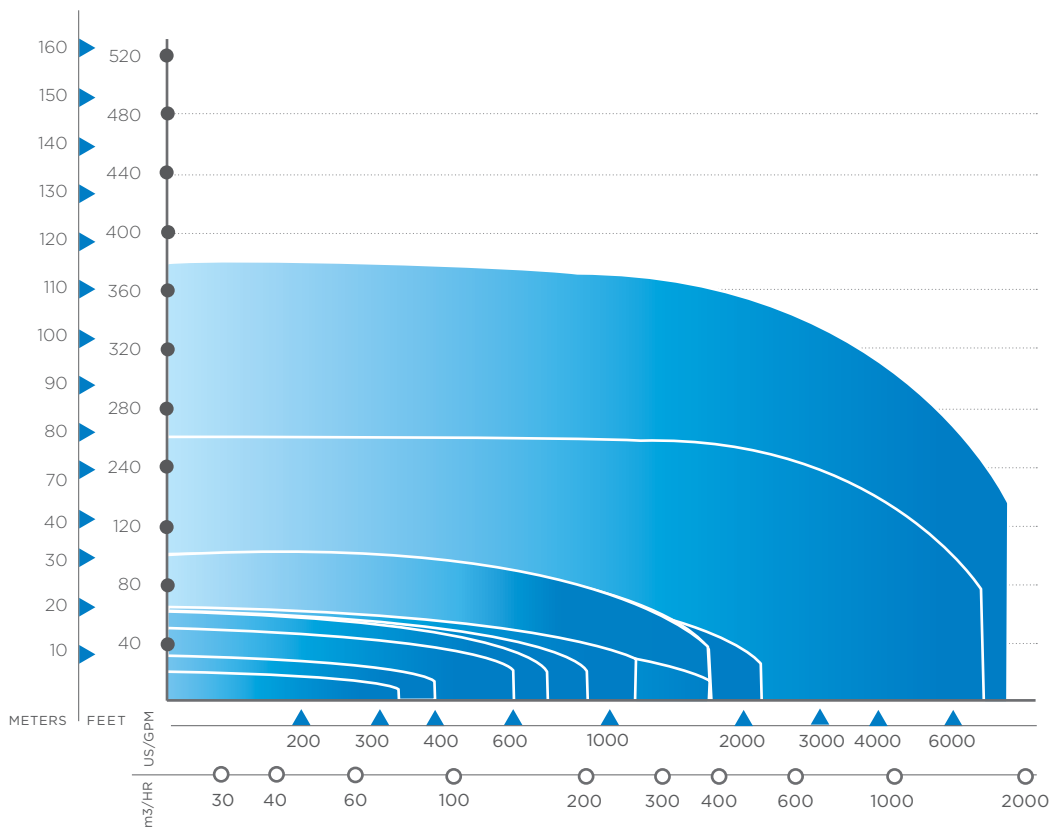

HEVVY SLURRY

CLASSIFICATIONS

At HEVVY PUMPS we were born out of our passion for pumping solids. The majority of pumping companies began life as a water pumping company. Therefore, if they now offer a “slurry” pump, they’ve simply adapted one of their water pumps to do a slurry pumps’ job. This is not always the ideal solution (similar to asking a pick-up truck to do a dump truck’s job).

To find the right solution for your application it is important to first understand what it is you are trying to pump. Slurries come in many shapes, sizes, weights, levels of abrasion or corrosion and consistency. For your convenience, **the industry defines slurries by classes**. We have included a very simplified chart (see below) to assist you in understanding what slurry class you might be dealing with. As always we are happy to help you choose the right solution for your application. Please give us a call if this is all as clear as well... slurry.

SLURRY TYPES: SILT | SAND | TAILINGS

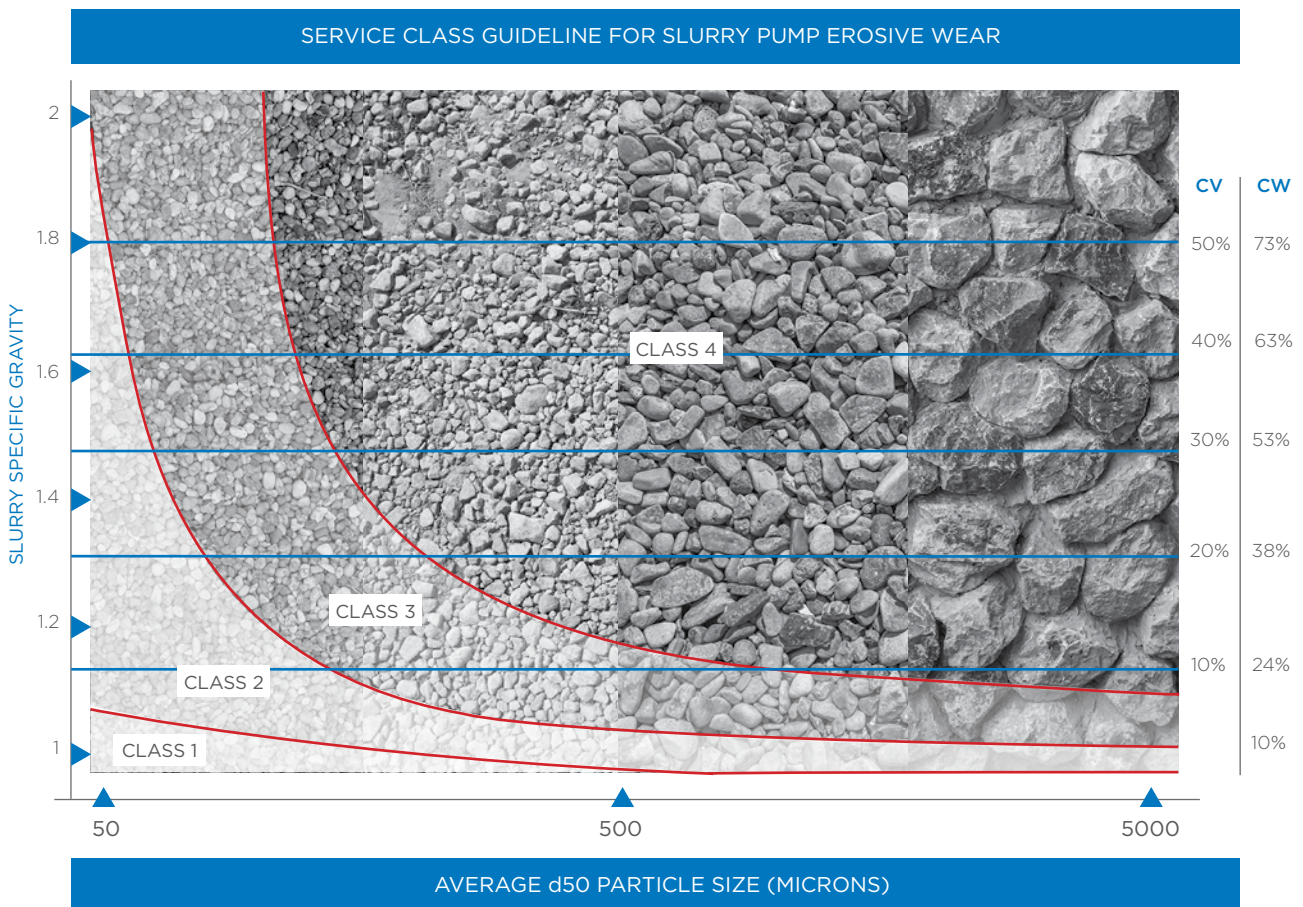

The above chart is for use as a guide only. It assumes 2.65 Ss silica-based solids. Adjust rating to account for solids of different abrasivity using ASTM G75-95. The chart is based on the Hydraulic Institute’s Slurry Class guideline. For more information about the HI Slurry Classes please visit <http://pumps.org> or call HEVVY PUMPS for assistance.

A SIMPLE GUIDE TO HEVY SUBMERSIBLE SLURRY PUMPS

- RECOMMENDED USE
- CAPABLE UNDER OPTIMAL CONDITIONS

	SLURRY CLASS			
Pump Model	1	2	3	4
HT				
HS				
HNS				



Need something Hevvier?

The **HT and HS Pump Series** are excellent submersible pump solutions for class 1 & 2 slurries up to 100HP.

What if you need more? The Hevvy HNS Series is the world's only modular submersible slurry pump with pressurized sealing technology, run dry capability, and even capable of passing a 5" rock. It is available up to 1000 HP and can handle Class 4 slurries. The HNS is available with four wet end choices and can pump up to 10,000 GPM.



Give us your worst

HEVY PUMPS is proud to offer a **complimentary pump audit** of your four worst pumping applications, complete with a report.

HEVY's No Risk Trial Program

Be confident that your HEVY PUMP will work with our **No Risk Trial Program**. All we need is a little information about your application and a commitment from you - when our pump meets the expectations that we both agree on - that you will keep the pump.

To find out more please contact your local Regional Manager for details or email applications@hevyumps.com



Toyo Pumps North America, Corp.
Hevvy Pumps, Inc.
1550 Brigantine Drive | Coquitlam, B.C. | Canada V3K 7C1
www.hevvyumps.com

The information that has been provided within the pages of this brochure has been compiled in good faith and to the best of **HEVVY PUMPS** ability.

However, the authors of this document make no warranty, of any kind, expressed or implied, and will not be held responsible, or liable, for errors or omissions resulting in any loss or damage caused, or alleged to be caused - directly or indirectly - by information contained within. Information is also subject to change at the discretion of **HEVVY PUMPS**.

Copyright 2019. All rights reserved. PBR-HT+HS-EN-R3

